

## **Installation Instructions**



### **PTM-B Tilt/Pivot Mount**

---

Premier Mounts  
3130 E. Miraloma Avenue  
Anaheim, CA 92806  
Phone: (800) 368-9700 Fax: (800) 832-4888  
techsupport@mounts.com www.mounts.com

IN-PTMB.R0

[www.muurbeugel.nl](http://www.muurbeugel.nl)



## TABLE OF CONTENTS

Warning Statements .....	3
Parts List .....	4
Installation Tools .....	4
Wood Stud Installation .....	5
Optional Concrete Installation .....	5
PTM-B Installation .....	6
PTM-B Adjustment .....	6
Attaching the Display .....	7
UFP-200 Adapter Plate .....	7
Technical Specifications .....	8
Warranty .....	8
Contact Premier Mounts .....	8

### Warranty

#### Limited Lifetime Warranty

All Premier Mounts products carry a limited lifetime warranty from ship date against defects in materials and workmanship. Premier Mounts is not liable for improper installation that results in damage to mounts, adapters, display equipment or personal injury.

### Contact Premier Mounts

In the event of missing and/or damage equipment, or technical questions, the following information can help in the completion of the installation.

Customer Service - (800) 368-9700  
 Technical Support - [techsupport@mounts.com](mailto:techsupport@mounts.com)



### Warning Statements

**WARNING:** THE WALL STRUCTURE MUST BE CAPABLE OF SUPPORTING AT LEAST A MINIMUM WEIGHT OF 50 LBS. IF NOT, THE WALL MUST BE REINFORCED. PROPER INSTALLATION PROCEDURE BY A QUALIFIED SERVICE TECHNICIAN, AS OUTLINED IN THE INSTALLATION INSTRUCTIONS, MUST BE ADHERED TO. FAILURE TO DO SO COULD RESULT IN SERIOUS PERSONAL INJURY, OR EVEN DEATH.

**WARNING:** SAFETY MEASURES MUST BE PRACTICED AT ALL TIMES DURING THE INSTALLATION OF THIS PRODUCT. USE PROPER SAFETY GEAR AND TOOLS FOR THE INSTALLATION PROCEDURE TO PREVENT PERSONAL INJURY.

**WARNING:** PRIOR TO THE INSTALLATION OF THIS PRODUCT, THE INSTALLATION INSTRUCTIONS SHOULD BE READ AND COMPLETELY UNDERSTOOD. THE INSTALLATION INSTRUCTIONS MUST BE READ TO PREVENT PERSONAL INJURY AND PROPERTY DAMAGE. KEEP THESE INSTALLATION INSTRUCTIONS IN AN EASILY ACCESSIBLE LOCATION FOR FUTURE REFERENCE.



Indicates that the power plug is to be disconnected from the power outlet.



Safety precautions must be taken at all times.



Warning and Caution statements.



A secure structure must support the weight, or load, of the display. When mounting to a wall that contains wooden studs, dead center of the wooden stud must be confirmed prior to installation.



Do not install on a structure that is prone to vibration, movement or chance of impact. Failure to do so could result in damage to the display and/or damage to the mounting surface.



Do not install near heater, fireplace, direct sunlight, air conditioning or any other source of direct heat energy. Failure to do so may result in damage to the display and could increase the risk of fire.



At least two qualified people should perform the installation procedure. Injury and/or damage can result from dropping or mishandling the display.



Recommended mounting surfaces: wooden studs and solid-flat concrete. If the mount is to be installed on any surface other than wooden studs, use suitable hardware (which is commercially available).









Contact Premier Mounts with any technical/ installation questions.

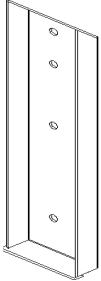

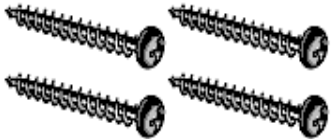
## Parts List

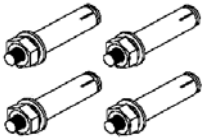
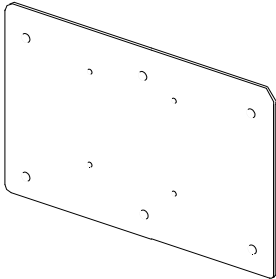
**NOTE:** This mount is shipped with all installation hardware and components. Make sure that none of these parts are missing and/ or damaged before beginning installation. If there are parts missing and/or damaged, please stop and contact Premier Mounts - (800) 368-9700.

<p>Mounting Backplate (Qty 1)</p> 	<p>Tilt/Pivot Mount (Qty 1)</p> 
<p>M4 x 10mm Phillips Head Screws (Qty 4)</p> 	<p>#14 x 2" Wood Screws (Qty 4)</p> 
<p>M6 x 35mm Set Screw (Qty 1)</p> 	<p>1/4" x 1-1/2" Wedge Anchors (Qty 4). These are used only for concrete applications.</p> 
<p>UFP-200 Plate (Qty 1)</p> 	<p>M4 x 10mm Flat Head Phillips Screws (Qty 6)</p> 
<p>M4 x 5mm Phillips Screws (Qty 4)</p> 	

## Installation Tools

Phillips Head Screw Driver

Soft Material/ Blanket

5/16" Drill Bit (for wedge anchors)

Tape Measure

Stud Finder (Sold Separately)

Portable Drill

Pencil

Level

Ratchet with 14mm Drive Socket

M3 Allen Wrench (Supplied)



### Wood Stud Installation



Determine where the mount location will be. Use a stud finder to locate the nearest wall stud.

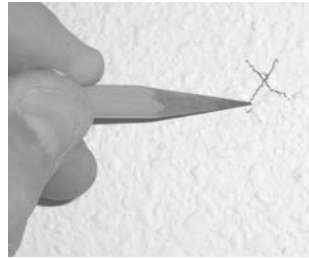

Once the stud has been located, use a pencil to mark the center of the stud.



Use the level (supplied) to make sure the backplate is level from top to bottom. Place the back plate over the first whole, and use a pencil to mark the rest of the holes.



Use a drill and a 1/8" drill bit to pre-drill the mounting holes.



Use the provided wood screws to attach the back plate to the mounting surface.

### Optional Concrete Installation



Drill the mounting holes where the marks were made with a pencil. Use a 5/16" concrete drill bit (commercially available).



Once the holes have been drilled, place the wedge anchor into the hole. Using a hammer, gently tap into place.



Correctly seated wedge anchor bolt.



Place the backplate over the wedge anchors once the wedge anchors have been correctly inserted into the mounting surface. Place the washer, locking washer and nut onto the threaded shaft and tighten.

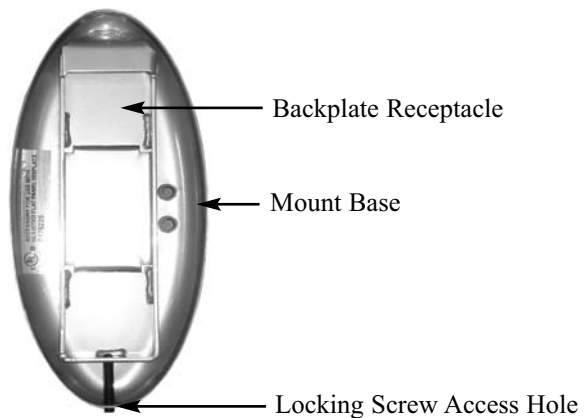



### PTM Installation

1. The reverse side of the mount must be mounted to the back plate that is attached to the wall. The back of the mount contains an elongated rectangle. The back plate receptacle must be placed over the top of the back plate, so that the entire mount “hangs” on the back plate.
2. Locate the access hole at the bottom of the mount base. Install the M6 x 35mm set screw with the M3 Allen wrench.
3. Turn the Allen wrench clockwise (viewed from below) until the screw is secure.

**WARNING:** Failure to fully tighten the locking screw may result in possible damage to your display.

### PTM Tension Adjustment

To adjust the tension of the PTM, use the 14mm socket and Allen Wrench. The tension nut is located on the face of the PTM.



Use the M3 Allen Wrench (supplied) to tighten the locking screw that is located on the bottom of the mount base. This locking screw will prevent the mount and display from being lifted off of the wall plate.

← M3 Allen Wrench



## Attaching the Display

1. Loosely tighten two (2) M4 x 10 phillip screws to the top of the mounting points.
2. Insert the head of the screws through the keyhole slots and then secure the bottom two (2) M4 x 10 phillip screws to secure the flat panel to the mounts, then tighten the upper M4 screws.

**CAUTION:** Do not over tighten the M4 screws.

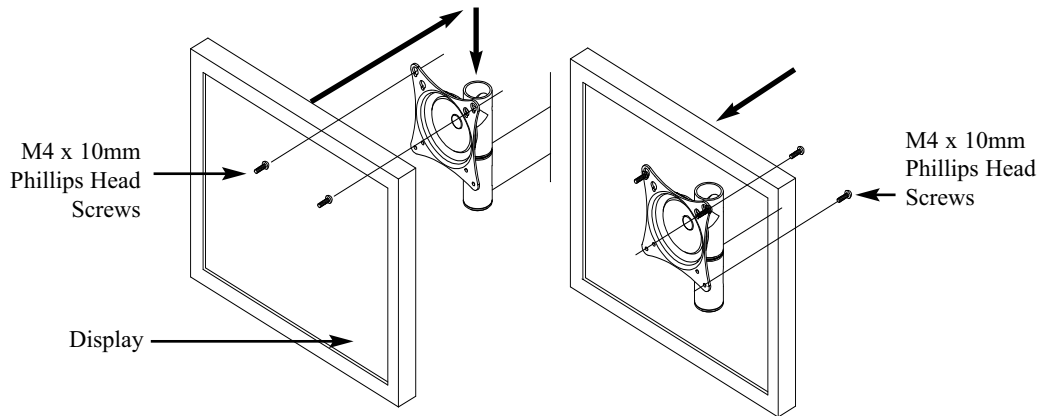

## UFP-200 Adapter Plate

1. Attach the UFP-200 Adapter Plate to the back of the display using the six (6) M4 x 10mm screws.
2. Attach the PTM mounting plate to the back of the UFP-200 using the four (4) M4 x 5 mm screws.

**NOTE:** If your flat panel is not a VESA 75/100, the UFP-200 Adapter Plate must be used.

**CAUTION:** DO NOT OVERTIGHTEN THE SCREWS.

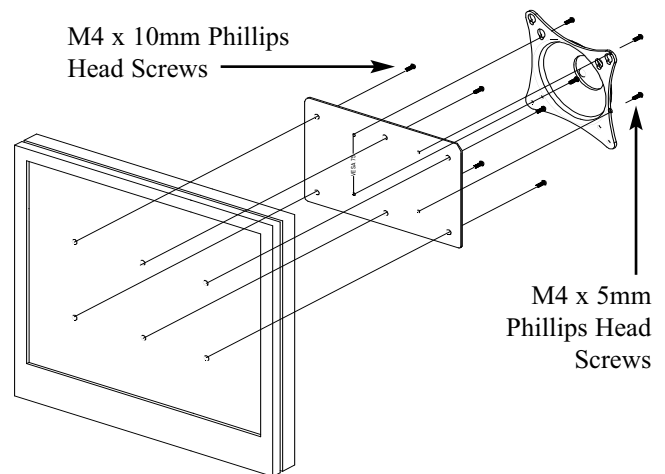

Use six (6) M4 x 10mm screws to attach the plate to the display (↖ - 6 total).

Install the top two M4 x 5mm screws into the UFP-200 plate. Do not thread tight.



For the PTM-B, it is suggested that the mount and adapter plate be attached to the display while the display is on the ground. The reason for this is because once the display is attached, there is limited space behind the unit to use a screwdriver to tighten the screws.



## Technical Specifications

All measurements in inches/(mm).

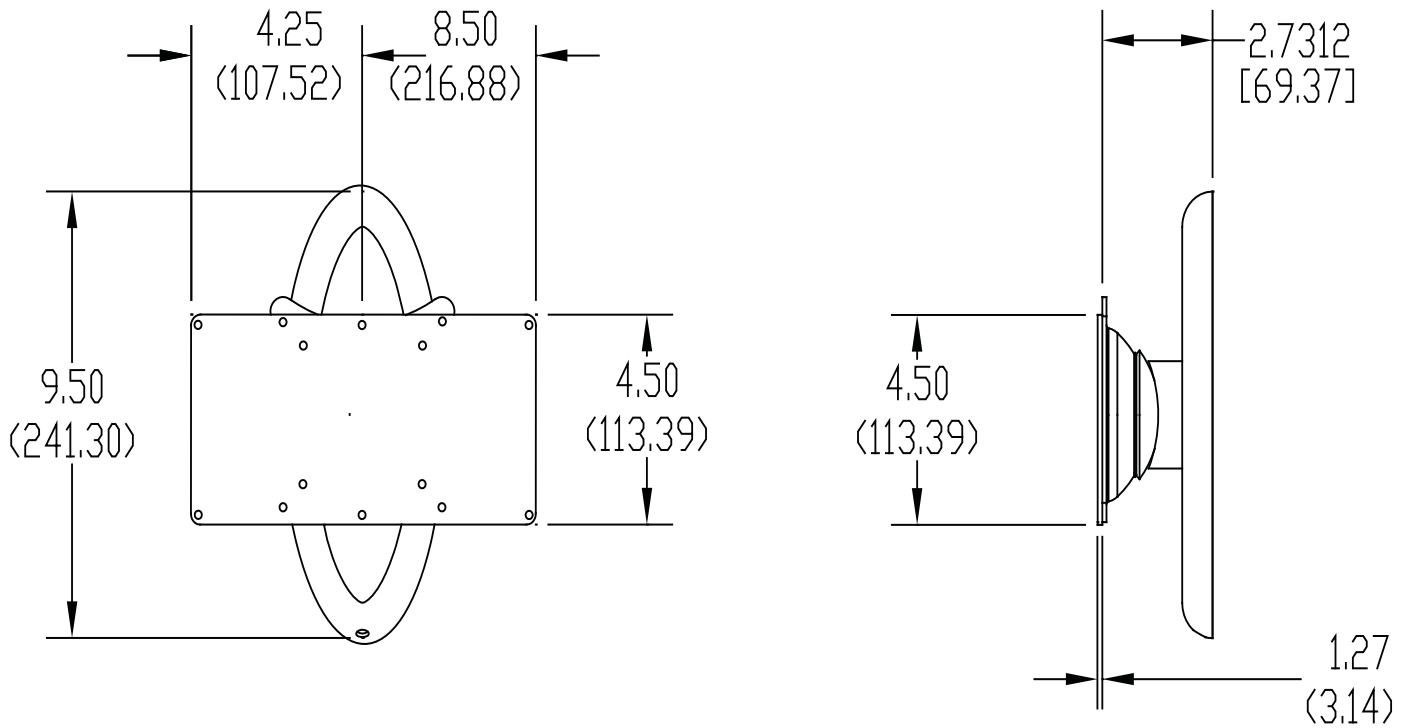

### NORTH AMERICA

3130 E. Miraloma Ave.  
Anaheim, CA 92806 USA  
USA and Canada -  
Phone: 800-368-9700  
Fax: 800-832-4888  
www.mounts.com

### EUROPE

Swallow House,  
Shilton Industrial Estate,  
Shilton, Coventry, England  
CV79JY  
Phone: +44 (0) 2476 614700  
Fax: +44 (0) 2476 614710

### AUSTRALIA, NEW ZEALAND, OCEANIA (DISTRIBUTOR)

P.O. Box 295  
Mordialloc Victoria 3195  
Australia  
Phone: 03 9586 6330  
www.premiermounts.com.au